



HEWLETT-PACKARD JOURNAL

TECHNICAL INFORMATION FROM THE -hp- LABORATORIES

Vol. 15, No. 1

PUBLISHED BY THE HEWLETT-PACKARD COMPANY, 1501 PAGE MILL ROAD, PALO ALTO, CALIFORNIA

SEPTEMBER, 1963



PRINTED IN U.S.A.

COPYRIGHT 1963 HEWLETT-PACKARD CO.

A BASIC NEW WIDE-BAND OSCILLOSCOPE WITH PLANNED ANTI-OBSOLESCENCE

An interesting new oscilloscope has been designed with new measurement capabilities and the probability of more in the future . . .

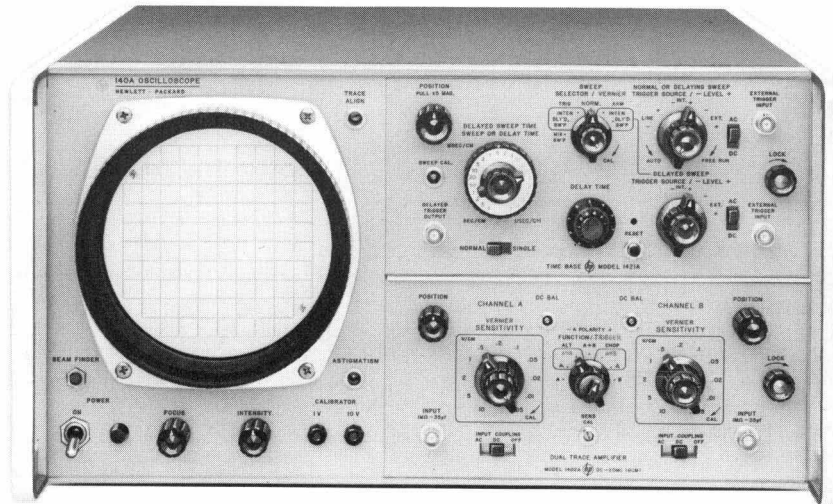

Fig. 1. For maximum flexibility, new -hp- Model 140A Oscilloscope has all deflection circuitry in plug-ins. Measurement range spans dc to 20 Mc and sensitivities to 10 $\mu\text{v}/\text{cm}$.

FOR some time it has been common for high-performance oscilloscopes to be designed so that they use plug-in circuits as a means of adapting to a variety of uses. Often, for example, the vertical input channel of an oscilloscope has been arranged as one plug-in unit, and the horizontal channel as another. By then selecting an appropriate plug-in unit for each channel, the user can tailor the oscilloscope to any of a variety of measurements.

A new, universal high-performance oscilloscope has now been designed in which the plug-in concept has been advanced to a much more sophisticated form. In this new instrument the customary two separated compartments that receive the plug-ins have been merged into one compartment. This single

compartment then serves two purposes. First, it permits a separate plug-in to be used for each channel

in the usual way when such is desired. But, secondly, it permits a single plug-in to be used for the

AMPLIFIER PLUG-INS				
Model	Description	Maximum Bandwidth*	Maximum Sensitivity	Features
1400A	Single-channel; Differential input	DC - 400 kc	100 $\mu\text{v}/\text{cm}$	Selectable upper cut-off frequency. Low dc drift
1401A	Dual-channel	DC - 450 kc	1 mv/cm	Can be used in differential configuration
1402A	Dual-channel	DC - 20 Mc**	5 mv/cm	Single channel operation with sum or difference of two inputs. Internal delay line. Internal syncing off one channel when in Chopped or Alternate mode.
1403A	Single-channel; Differential input	0.1 cps - 400 kc	10 $\mu\text{v}/\text{cm}$	Selectable upper and lower cut-off frequencies

TIME DOMAIN REFLECTOMETER				
1415A	Fast step generator and sampling channel	Risetime: 150 psec	1 mv/cm	Max sweep speed: 0.1 nsec/cm

SWEEP GENERATOR PLUG-INS				
Model	Description	Sweep ranges	Magnifier	Features
1420A	Triggered sweep	0.5 $\mu\text{sec}/\text{cm}$ to 5 sec/cm	X10	Automatic triggering; single sweep
1421A	Two sweep generators for delaying sweep	0.1 $\mu\text{sec}/\text{cm}$ to 1 sec/cm	X5	Automatic triggering; single sweep mixed sweep. Sweep delay: 0.1 μsec to 10 sec.

Front cover:
New -hp- Model 140A Oscilloscope with plug-in Model 1415A Time Domain Reflectometer is examined by project leader Richard Monnier and Lee Moffitt of the -hp- Oscilloscope Engineering Department.

*All dc amplifiers have optional ac coupling
**Up to 6 cm deflection; 15 Mc @ 10 cm

two channels when that is advantageous.

The value of this arrangement and the fact that a single plug-in can be and is advantageous has already been established. The front cover, for example, shows a new type of plug-in which encompasses both channels.

This new plug-in adapts the oscilloscope to pulse-echo evaluation of the quality of transmission line systems with signals having bandwidths extending up into the gigacycle (kilomegacycle) region. Measurements in this frequency region are made by a sampling technique with all the necessary pulse and sampling circuitry contained completely within the one plug-in. The basic oscilloscope is changed from real-time to sampling operation simply by a change of plug-ins.

The new plug-in arrangement, together with the variety of plug-ins that have been designed, makes the new oscilloscope unmatched in its class as to the measurements it will make. Further, the arrangement provides an inherent guard against obsolescence, since it is adaptable to future developments in the electronics art.

The actual frequency coverage and voltage sensitivity of the oscilloscope are determined primarily by the plug-ins selected. As shown in the accompanying table, plug-ins have been designed to permit measurements to above 20 megacycles and down to 10 microvolts per cen-

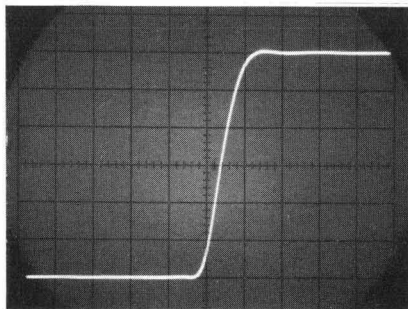

Fig. 2. Oscillogram of step response of Model 1402A dual-channel 20-megacycle plug-in operating in Model 140A Oscilloscope. Sweep speed is 20 nsec/cm.

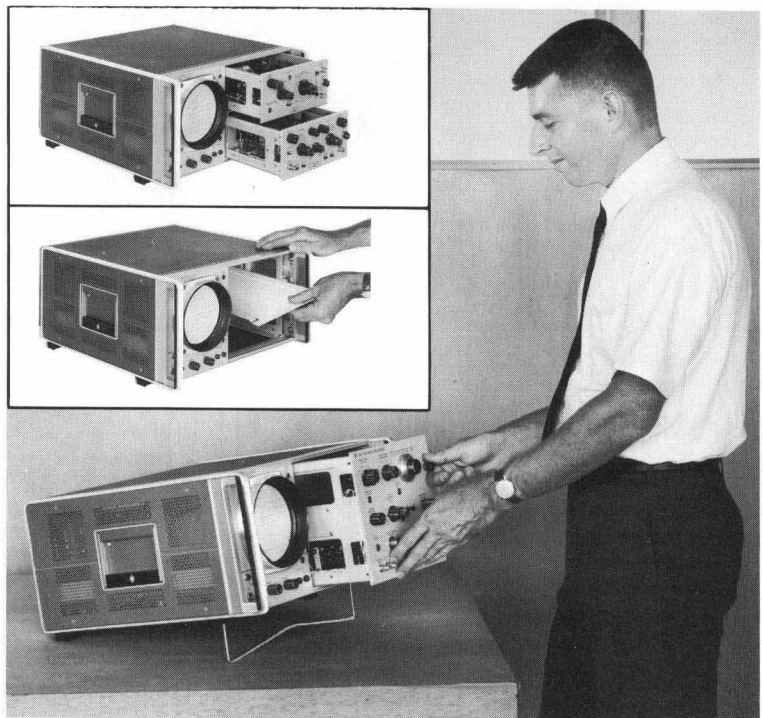

Fig. 3. New Model 140A Oscilloscope accepts two small-size plug-ins or one double-size plug-in, here being installed by Philip G. Foster, -hp- mechanical design engineer. Plug-in compartment has removable divider shield to accommodate either size.

timer. In addition, of course, the sampling technique enables the study of signals with rise times extending into the nanosecond region. It is also practical to consider the use of custom-built plug-ins.

Since the actual functional capabilities of the oscilloscope are determined by the plug-ins, the "main frame" is designed as a display device and as a power supply both for the CRT and the plug-ins. The power supplies have been designed with ample margin to power present and future plug-ins. A total of 140 watts of regulated dc power, for example, is available to the plug-ins.

CRT

The overall simplicity of the oscilloscope circuitry has been permitted to a large extent by the use of a special cathode-ray tube designed in the -hp- crt laboratory. The new tube is of the "radial-field" type developed for the -hp- Model 175A 50-megacycle oscilloscope and is described in another

article herein. In this tube equal sensitivities are achieved for the horizontal and vertical deflection characteristics, thus permitting identical plug-ins to be used in each channel such as when X-Y displays are required.

The new cathode-ray tube is a 5-inch size and, in contrast to the smaller dimensions that have generally prevailed, has a vertical deflection of 10 centimeters. The graticule for the tube is the -hp- developed internal type which has no parallax error. The tube front is treated so that reflections from its face are essentially non-existent.

The crt is operated at a high accelerating voltage of 7.5 kv. This level, together with aluminization of the tube and other factors, gives a bright trace and a writing rate compatible with the speed of the plug-in amplifiers.

VERTICAL SYSTEM

Undoubtedly the most representative usage situation for an oscilloscope of this type is one in which an

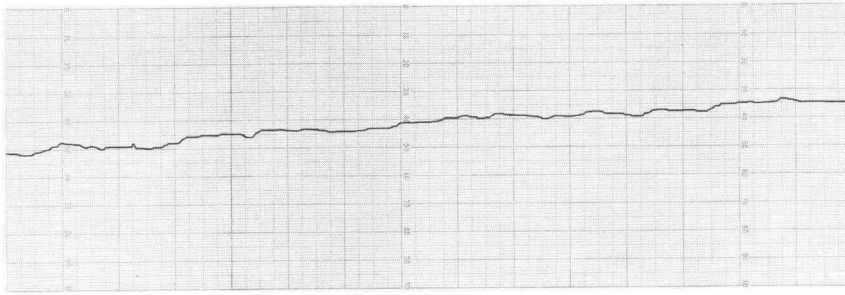

Fig. 4. High stability of Model 1400A $100 \mu\text{v}/\text{cm}$ amplifier is shown by one-hour recording of dc drift. Major vertical divisions represent 0.1 mv referred to plug-in input, indicating drift of less than $0.2 \text{ mv}/\text{hour}$ after warm-up.

amplifier-type plug-in is desired for the vertical system and a sweep generator for the horizontal. It is thus incumbent upon the designers to make available a broad variety of plug-ins to meet foreseeable applications.

For the vertical system the plug-ins that have been designed include on the one hand the wide-band, dual-channel, medium sensitivity type of plug-in that has been the workhorse of high-performance oscilloscopes. The plug-in of this class that has been designed for the oscilloscope has a number of pertinent features to facilitate measurements. Bandwidth of each (identical) channel is in excess of 20 megacycles, while sensitivity is 5 millivolts/centimeter. The quality and speed of the step response of this plug-in are indicated in the oscillogram of Fig. 2. The plug-in also includes a built-in delay line which enables viewing the portion of the waveform that triggers the sweep.

At the opposite end of the vertical plug-in group is a differential-type amplifier that has both a very high common-mode rejection of 94 db and a very high sensitivity of 10 microvolts/cm. In this plug-in the upper cut-off frequency has been made selectable at the front panel so that unnecessary bandwidth, hence unnecessary noise, can be eliminated from a given measurement. Similarly, the lower cut-off frequency is also selectable to accommodate measurements where it may be desired to exclude low-frequency

noise such as the $1/f$ noise from external semi-conductor circuits under test.

Between these two amplifiers are additional amplifiers whose characteristics are arranged in a series of graded steps. Most measurements can thus be met with instrument characteristics approaching the optimum permitted by the state of the art. All of the amplifiers have been designed to achieve high dc stability. This is demonstrated in Fig. 4 which shows on an enlarged scale the slight dc drift in one of the high-sensitivity plug-ins. This drift is approximately $0.2 \text{ mv}/\text{hour}$, which is approximately the same as that permitted by vacuum tubes themselves¹.

¹Valley and Wallman, Vacuum Tube Amplifiers, MIT Rad. Lab. Series No. 18; P. 412.

MULTIPLE X - Y DISPLAYS

The fact that the cathode-ray tube used in the new oscilloscope has been designed with equal vertical and horizontal deflection sensitivities together with the fact that the plug-ins directly feed the deflecting plates with no intervening circuitry enables identical plug-ins to be used in the vertical and horizontal inputs to obtain identical X- and Y-channel characteristics. Hence, X-Y displays such as Lissajous figures can be obtained by inserting identical plug-ins in each channel. If two single-channel plug-ins are used, a single X-Y display will be obtained. However, dual or four-channel amplifiers can be used to obtain multiple X-Y displays.

Fig. 6, for example, shows the result of using a dual-channel plug-in in the vertical channel and a single-channel plug-in in the horizontal channel to display two separate events against a third event. Two completely independent displays may be achieved by using two dual-channel plug-ins. Similarly, four independent displays may be achieved by using two four-channel plug-ins (to be available).

HORIZONTAL SYSTEM

Since the character of the horizontal system, like that of the vertical, is determined by the plug-

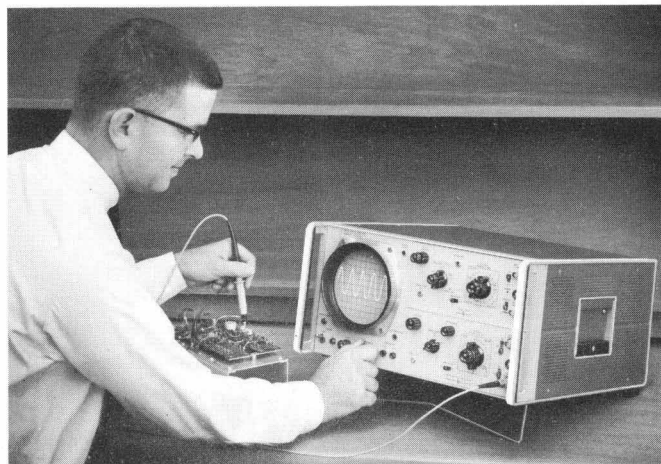

Fig. 5. -bp- Model 140A Oscilloscope being used with Model 1403A $10 \mu\text{v}/\text{cm}$ ac differential plug-in.

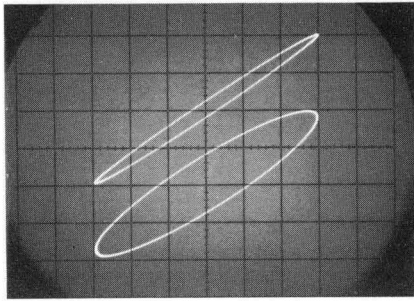

Fig. 6. Dual X-Y displays can be obtained with new oscilloscope, as shown by above single-exposure oscillogram comparing phases at two different places in test circuit.

ins used, it is not necessary to prescribe the future use of the oscilloscope in the irrevocable way that it is when the horizontal system is self-contained. For example, a choice between a delayed-type or a non-delayed type sweep system can be altered at any future time to suit the instrument to changing applications.

Two plug-ins have presently been designed for the horizontal system. Both are time base units, one being a general-purpose time base and the second a time base with delayed-sweep arrangement. Both are designed as high-performance units which are unsurpassed as to their general flexibility. Performance data are given in another section herein.

REFLECTOMETRY

As mentioned earlier, the anti-obsolescence factor of the new oscilloscope is well demonstrated by the development of the Time Domain Reflectometer plug-in. This plug-in converts the oscilloscope to a sampling-type system with more than a 2.3-gigacycle bandwidth. It also contains an internal step generator providing for external use a very fast step with a rise time of less than 50 picoseconds.

The basis of operation of the plug-in is shown schematically in Fig. 7. The internally-generated fast step is connected to the external transmission system to be tested.

Discontinuities and impedance mismatches in the external system will then reflect a portion of the step and this reflection will be displayed following the leading edge of the step itself. The magnitude of the displayed reflection is then a direct measure of the magnitude of the reflection coefficient of the discontinuity, while the time-position of the displayed reflection is a direct measure of the physical location of the discontinuity in the transmission system. Reflections as low as 0.1% can be measured, and multiple discontinuities physically spaced as close as 1 cm on a typical transmission system can be resolved.

Additional information on the Reflectometer plug-in and its uses is given later herein in a separate article. In addition, an early issue of the *Hewlett-Packard Journal* will discuss the general subject of time domain reflectometry in detail.

1% CALIBRATOR

Among other matters of interest about the oscilloscope is the internal calibrator which provides 10-volt and 1-volt line frequency square waves at the panel for probe compensation, amplifier gain adjustment, and sweep time calibration. The calibrator amplitude is accurate within 1% over a range of $\pm 10^\circ\text{C}$ from the temperature at which it is calibrated, while over the much wider range of from 0°C to 55°C it is accurate within $\pm 3\%$.

FUTURE PLUG-INS

The possibilities for future plug-ins are practically unlimited. In the near future there will be available two new vertical amplifier plug-ins. One will be a four-channel plug-in with a bandwidth extending from dc to 15 or more megacycles. The second will be a dual-channel dc to 5 megacycle amplifier with a maximum sensitivity of 10 mv/cm. This plug-in will not include the delay lines or sync amplifier of the present 20-megacycle dual-channel amplifier.

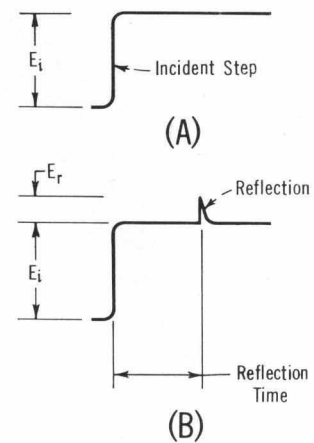

Fig. 7. Reflectometer plug-in generates very fast step (a) for testing external systems. Mismatches in system reflects portion of step (b), permitting magnitude and location of mismatch to be identified.

GENERAL

The oscilloscope includes the convenient *-hp-* beam finder control on the front panel to facilitate locating an off-screen trace. The external Z-axis modulation input is located on the rear panel.

The cabinet is the new *-hp-* modular style which can be used on the bench, stacked with other *-hp-* instruments, or rack mounted. Depth behind panel is $16\frac{3}{8}$ inches.

The oscilloscope is fan cooled and weighs approximately 45 pounds including plug-ins.

ACKNOWLEDGMENT

The design and development of the 140A and its plug-ins represents the combined efforts of a number of engineers in the *-hp-* Oscilloscope Division. Included were Andi Aré, Gordon A. Blanz, George H. Blinn, Jr., Phillip G. Foster, James L. Green, William L. Grein, Wayne M. Grove, Charles H. House, Robert L. Huebner, Ralph H. Jensen, Scott McClendon, Thomas D. McLaughlin, Lee R. Moffitt, John W. Riggan, Johan J. Sverdrup, the undersigned, and *-hp-* Oscilloscope Engineering Manager Norman B. Schrock. David E. Chaffee's cathode ray tube design was a key contribution to the development of the oscilloscope.

—Richard E. Monnier

THE TIME DOMAIN REFLECTOMETER

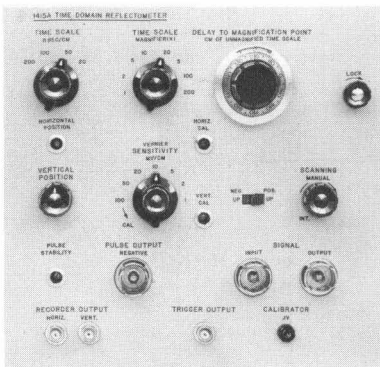

Fig. 1. Time Domain Reflectometer plug-in (-hp- Model 1415A), has self-contained fast-step generator and sampling oscilloscope channel.

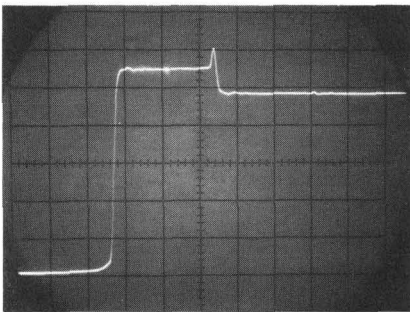

Fig. 2. Impedance mismatch between 50-ohm coaxial cable and 39-ohm termination is shown by this oscillogram made with -hp- Model 140A oscilloscope and Model 1415A Time Domain Reflectometer plug-in. Sharp spike results from inductance of termination leads. Bright dot corresponds to setting of calibrated dial on delay control, permitting quick location of discontinuities. (Sweep speed: 4 nsec/cm)

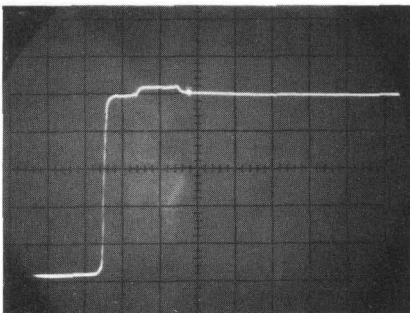

Fig. 3. Difference in cable impedances is shown by this oscillogram. Initial portion of step represents 3 ft of 50-ohm cable. Raised portion is caused by 5-ft cable that has 52-ohm impedance. Remaining portion of step represents 50-ohm cable termination.

HIGH-resolution time-domain reflectometry measurements are made practical by the Model 1415A TDR plug-in for the Model 140A Oscilloscope. Time domain reflectometry is a relatively new impedance-measurement technique which gives accurate, quantitative, easy-to-interpret information about mismatching, loss, reflection coefficients, and other parameters of electrical transmission systems.*

The technique, analogous to the pulse-reflection principle used in radar, has been used for some time as a means of locating faults on long electric power and telephone transmission systems. The extremely fine resolution available in the Model 1415A, however, enables application of the pulse-reflection technique to systems with much smaller dimensions. The Model 1415A plug-in with the Model 140A Oscilloscope displays cable discontinuities separated by only fractions of an inch.

In the new plug-in, a step is generated and sent into the transmission system being studied. Impedance variations reflect the incident step just as physical objects reflect the pulsed RF energy of a radar set. The CRT display, corresponding roughly to a radar A-scope presentation, shows the location, magnitude, and type of impedance variations which cause the reflections.

The plug-in contains a fast tunnel-diode generator ($t_r < 50$ ps) and a 50-ohm sampling oscilloscope channel. The system risetime is less than 150 ps, corresponding to a bandwidth of more than 2.3 Gc. The extremely fast risetime permits resolution of impedance discontinuities spaced as closely as 1 cm.

The fast risetime and high sensitivity of the Model 1415A open the way for a wide range of uses. A typical application concerns the measurement of reflections introduced by cable terminations, as shown in Fig. 2. Here, the step stimulus is seen by the scope as it passes through the sampling gate before entering 3 ft. of 50-ohm cable. The sharp spike is a reflection caused by inductance in a 39 ohm resistor across the end of the cable. The impedance mismatch between cable and resistor causes the negative step following the spike.

Evaluation of cable impedances represents another application. Fig. 3 shows a raised portion on the step caused by a 5-ft. section of 52-ohm cable connected between a true 50-ohm cable and a 50-ohm termination. Fig. 4 demonstrates how several discontinuities along a section of transmission line can be located easily and analyzed separately, a difficult task to perform by conventional standing-wave measurements. Fig. 4 also shows the ability of time domain reflectometry to distinguish small discontinuities in the presence of large ones.

The Model 1415A can be used in the reflectometer mode with transmission systems up to 1000 feet in length. A calibrated delay, using a moveable bright dot on the trace as an indicator, greatly simplifies location of an impedance discontinuity and enables precise measurement of time displacements. Reflections of $\pm 100\%$ down to $\pm 0.1\%$ can be observed because of the large amount of vertical magnification that is possible without overload. This is a dynamic range of 60 db.

In addition to its applications in reflectometry, the Model 1415A is useful for transient response measurements of the transmission char-

*H. Halverson, "Testing Microwave Transmission Lines Using the Sampling Oscilloscope," *Electronics*, 30 June 61.

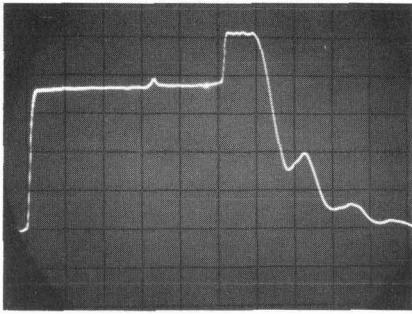

Fig. 4. Antenna system is examined here with Time Domain Reflectometer. Various impedance discontinuities can be identified separately and located by position on trace. Shape of reflection discloses nature of discontinuity.

acteristics of filters, cables, attenuators, and so on. Also, since the Model 1415A contains both a fast rise time pulse generator and a sampling oscilloscope channel, it offers an inexpensive means of measuring the risetime of amplifiers. With a system risetime of less than 150 ps when used in this manner, the Model 1415A is capable of measurements on all but the fastest state-of-art circuits.

The Model 1415A also serves as a sampling oscilloscope for the study of waveforms in fast pulse circuits, provided that the circuits are capable of being triggered at the fixed 200 kc sampling rate. The plug-in has a manual scan capability, and also has signal outputs for recording the CRT display with larger dimensions on an X-Y recorder.

—Lee R. Moffitt

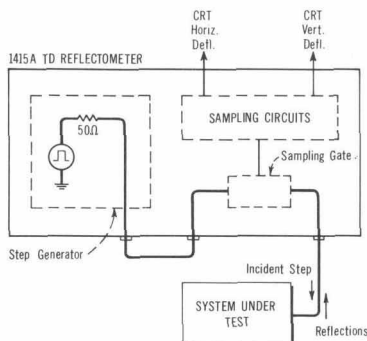
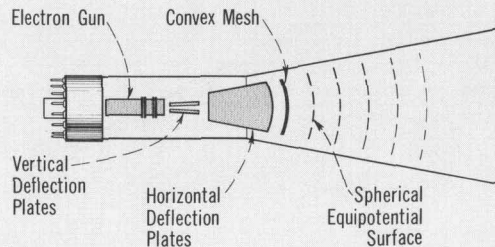

Fig. 5. Step generator in Reflectometer has 50 ohm source impedance which absorbs reflections traveling back through Sampling Gate.

THE RADIAL FIELD CATHODE-RAY TUBE



Curved mesh in new CRT terminates post-accelerating voltage lines of force; resulting equipotential surfaces are spherical.

HIGH deflection sensitivity and a large, bright display are realized in the new cathode-ray tube used in the Model 140A Oscilloscope. In contrast with conventional cathode-ray tubes in which high post-accelerating potentials, necessary for brightness, reduce deflection sensitivity and limit the vertical scan, the new tube achieves a sensitivity for both vertical and horizontal deflection of 12.5 v/cm and a 10 cm scan with an accelerating potential of 7.5 kv.

In a conventional tube, fringing electrostatic fields around the exit side of the deflection region tend to bend the electron beam back toward the longitudinal axis of the tube. This does not occur in the radial electrostatic field developed in the cathode-ray tube used in the Model 140A.

In the radial field tube, a fine-grained, curved, high-transmission metallic mesh is placed on the exit side of the deflection area. The mesh establishes a ground plane for the post-accelerating field so that the resulting equipotential surfaces are truly spherical, creating a radial electrostatic field. Not only does this field prevent scan demagnification when a high post-accelerating potential is used, but it actually achieves a small degree of linear scan magnification. Deflection defocusing likewise is minimized, though a front panel astigmatism control is provided to compensate for any shift in the dc level at the deflection plates as plug-ins are changed.

The new tube also features the popular *-hp-* internal graticule, which eliminates viewing parallax by placing the graticule in the same plane as the phosphor. Unless otherwise specified, the P31 phosphor, the brightest as well as the most burn-resistant of the general purpose-phosphors, is supplied in the CRT.

AMPLIFIER PLUG-INS

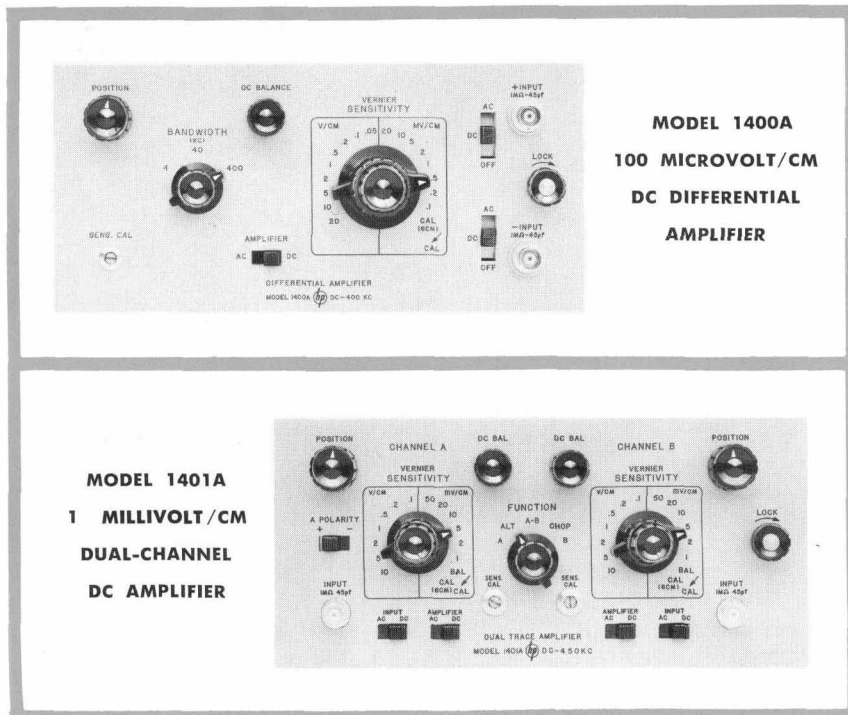

MODEL 1400A
100 μ V/CM DIFFERENTIAL AMPLIFIER

This amplifier is especially suited for low-level measurements of signals that have an essential dc component, as in tests involving thermocouple, strain gage or other slowly-varying signals. The amplifier achieves its high performance through use of a four-stage, hybrid tube-transistor circuit similar in concept to the amplifiers used in the -hp- 130C sensitive dc oscilloscope.*

DC stability is an important characteristic of this amplifier. Extreme care has been taken to minimize all sources of drift so that the drift rate is representative of the state-of-the-art in direct-coupled amplifiers designed for considerable ac bandwidth. The dc drift of a typical 1400A plug-in is illustrated in the recording of Fig. 4 on p. 4.

The balanced amplifier configuration permits two inputs which may be used together or separately. A positive voltage at the + input deflects the trace upwards while a positive voltage at the - input deflects the trace downwards. When both inputs are used, the difference between the two applied signals is displayed. Fig. 1 shows how hum pickup and other unwanted common mode signals are removed from the desired waveform when the amplifier is thus used.

A three position slide switch at each input allows DC coupling, AC coupling, or an OFF position. OFF opens the signal path and grounds the corresponding input grid so that the opposite input may be used for single-ended signals.

*J. C. Strathman, "A DC - 500 KC Oscilloscope with Extended Measurement Capabilities," Hewlett-Packard Journal, Vol. 13, No. 12, August 1962.

FOUR amplifier plug-ins for use with the 140A oscilloscope are described here. Sensitivities and bandwidths available in these four plug-ins enable them to perform an exceptionally wide range of measurements. A description of another plug-in, the Model 1415A Time Domain Reflectometer, is given on p. 6.

MODEL 1401A
1 MV/CM DUAL CHANNEL PLUG-IN

This general-purpose dual-channel amplifier, with an upper frequency response higher than 450 kc, is well suited for the majority of low-frequency laboratory and testing applications. Either amplifier channel may be viewed individually, or both channels may be displayed together, either alternately during successive horizontal sweeps (*Alternate mode*) or during the same sweep by gating the two amplifiers alternately at a 100 kc rate (*Chopped mode*).

The difference between the two input signals is presented when the plug-in is switched to the *A-B mode*. Common-mode rejection of at least 40 db is achieved when the amplifier is thus used. Since each input has a separate attenuator, signals of widely differing magnitudes can be accommodated. This can be useful for such purposes as examining

the distortion products of an amplifier by applying the amplifier output to one scope channel while the amplifier input is "subtracted" from the displayed waveform through the other scope channel.

The dc stability of this plug-in is excellent. If, however, a dc reference is not important, drift can be eliminated completely by switching the front panel *Amplifier AC-DC control* to *AC*. This increases the amount of feedback at low frequencies by placing a capacitor in series with a resistive divider in the feedback network. The low frequency 3 db limit then is 10 cps on the 1 mv/cm attenuator range, and is proportionately lower on the less sensitive ranges, being approximately 1 cps on the 10 mv/cm range.

A choice of dc or ac coupling is also provided at the input. When the input is ac coupled, voltages up to 600 volts off ground may be applied. The low frequency 3 db point in this case is below 2 cps.

The three-stage hybrid tube-transistor amplifier has a high enough open-loop gain to insure that the closed-loop gain is determined essentially by the feedback resistors. Overall calibration therefore is little affected by variations in tube and transistor parameters.

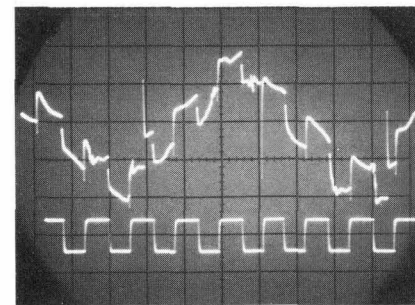

Fig. 1. Double-exposure oscillogram shows how hum and other transients in upper trace can be cancelled out by use of differential connection as provided on amplifier plug-ins.

In applications where the full amplifier bandwidth is not required, noise components can be reduced by restricting the amplifier passband (similar to the signal-to-noise improvement shown in Fig. 2 for the Model 1403A amplifier). A front panel switch allows the user to select upper bandwidth limits of 400 kc, 40 kc, or 4 kc.

High gain stability is achieved through a large amount of degenerative feedback. Open loop gain is so high that closed loop gain is completely determined by the feedback resistors, insuring stable, long-term calibration. The eleven most sensitive attenuator ranges, from 100 $\mu\text{v}/\text{cm}$ to 0.2 v/cm , are selected by changing the feedback factor. A frequency compensated attenuator at each amplifier input extends these ranges up to 20 v/cm .

In those situations where dc coupling is not necessary, drift is eliminated completely by a front panel switch which inserts a capacitor into the feedback network, as was described for the 1401A dual-channel plug-in. The lower cut-off frequency then is 20 cps, at the highest amplifier sensitivity (100 $\mu\text{v}/\text{cm}$) and it decreases proportionally as sensitivity is reduced.

On less sensitive ranges (50 mv/cm and above), dc drift is insignificant. Hence, these ranges are always dc-coupled to eliminate the long recovery times characteristic of ac coupling following an overload.

**MODEL 1403A
10 $\mu\text{V}/\text{CM}$ DIFFERENTIAL AMPLIFIER**

The 1403A 10 $\mu\text{v}/\text{cm}$ ac-coupled amplifier plug-in is intended for applications requiring the highest sensitivity which can be obtained practically at reasonable bandwidth and price. Besides high sensitivity and wide bandwidth, this amplifier has low noise and extremely high common mode rejection. Although designed for balanced signals on all sensitivity ranges, the amplifier can be used

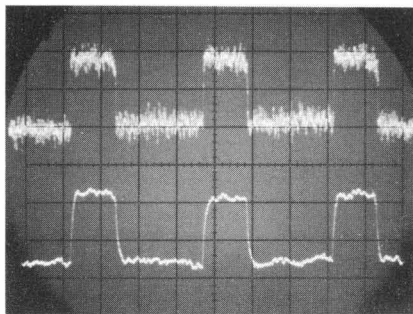
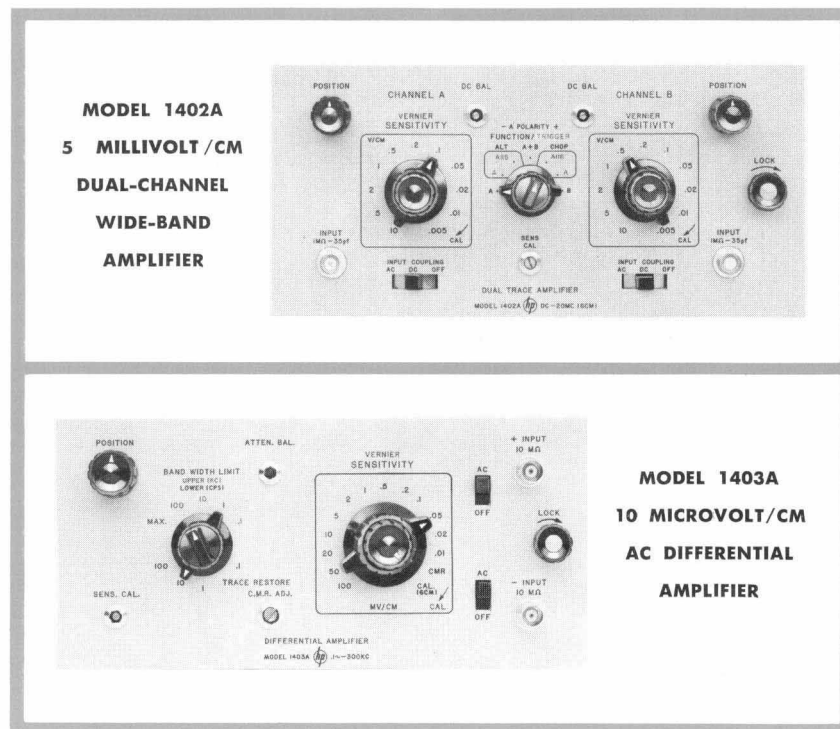

Fig. 2. Adjustable bandwidth of high-sensitivity plug-ins can be used to improve signal-to-noise ratio of low frequency signals, as in this double-exposure oscillogram.



for single-ended signals simply by switching one input to OFF, as with the 1400A sensitive dc amplifier.

Low amplifier noise is achieved through use of high- g_{m1} premium-quality triodes in the input circuit. On the most sensitive range with inputs shorted, noise is less than 20 μv peak-to-peak with 100 kc bandwidth. If circumstances allow, this noise can be diminished even further as shown in Fig. 2 by reducing upper and/or lower limits.

Extreme care has been taken to reduce hum interference to a sufficiently low level to eliminate the need for a 60-cps line frequency rejection filter in the signal path. Although such filters can eliminate residual hum picked up from the main frame, they can also severely distort complex signals.

High common-mode rejection is important in amplifiers which have extremely high sensitivities. When both the plus and minus inputs are used to measure balanced signals, interference picked up on the signal leads cancels itself. The 1403A uses a unity gain circuit which senses signals that are in phase at both inputs. The circuit drives the cathode and plate supplies of the input stage accordingly so that the common-mode signal does not change the input tube operating points. This arrangement gives a common-mode rejection on the most sensitive ranges of at least 94 db for interference between 10 cps and 10 kc up to 10 volts peak-to-peak in amplitude.

The input resistance is 10 megohms for each input and is always ac-coupled, allowing dc isolation up to 600 volts.

A *Trace Restore* position on the bandwidth switch grounds the amplifier coupling capacitors to quickly drain any charge accumulated during a severe overload.

**MODEL 1402A
WIDE BAND PLUG-IN**

The 1402A dual-channel wide-band plug-in is suitable for a broad range of applications because of the 5 mv/cm sensitivity that this plug-in provides along with its wide bandwidth. Clean transient response (Fig. 2 on p. 3) makes this a useful instrument for video and fast pulse waveforms. Bandwidth is such that a swept frequency signal, referenced to a 6-cm deflection amplitude at low frequencies, is no more than 3 db down at 20 Mc. For signals referenced to a full 10-cm deflection, the 3 db point is above 15 Mc. The amplifier's linearity is such that signals can be positioned anywhere within the display area without distortion of the waveform.

A dual-coaxial delay cable is included in the signal path to permit the leading edge of the signal which initiates the sweep trigger to be visible at the start of the sweep. A sync amplifier, placed ahead of the delay line, can be switched by a front panel switch to operate from one channel only, enabling stable, internal triggering from the one signal even when

the plug-in is in the *Chopped* mode of operation.

The two channels may each be used alone, or presented at the same time in either the *Alternate* or *Chopped* modes. In addition, they may be summed algebraically; a polarity-reversing switch on one channel enables the oscilloscope to present either the sum or difference of the two input signals.

SWEEP GENERATOR PLUG-INS

MODEL 1420A SWEEP GENERATOR PLUG-IN

The Model 1420A is a general-purpose time base plug-in which has fast sweep speeds and high-frequency triggering capabilities to make it compatible with

wide-band vertical amplifiers as well as those with the narrower bandwidth limits. Twenty-two calibrated sweep time ranges from 5 sec/cm to 0.5 μ sec/cm are provided, all of these being calibrated typically within 1%. A $\times 10$ magnifier, useful on all sweep ranges, extends the fastest sweep speed to 50 nsec/cm.

Excellent sweep linearity, even at the fastest sweep speeds, is achieved through use of a Miller integrator sawtooth generator, a differential cascode sweep amplifier, and cathode follower drive to the CRT deflection plates.

Automatic triggering, which displays a baseline at a 40-cps rate in the absence of an input signal, can be used with signals up to 500 kc that produce more than $\pm 1/2$ cm deflection. No adjustment of the trigger level control is required in the automatic mode. Optionally, the automatic triggering feature may be disabled so that any amplitude level on the input

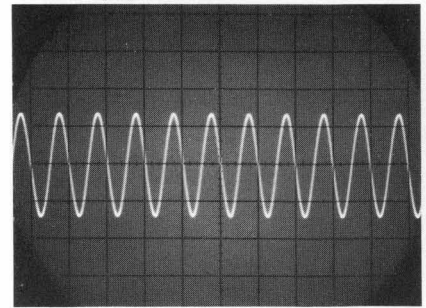

Fig. 3. Freedom from trigger jitter is demonstrated by this 1-second exposure with Model 1420A Sweep Generator triggering from displayed 20 Mc sine wave.

signal may be selected as the triggering point. This is effective on signals of frequencies up to 20 Mc, as shown in Fig. 3. Front panel switching also permits single-sweep operation, useful for photo-

AMPLIFIER PLUG-INS

SPECIFICATIONS

-hp-

MODEL 1400A

DIFFERENTIAL AMPLIFIER

SENSITIVITY:

100 μ v/cm to 20 v/cm; 17 calibrated ranges in 1, 2, 5, 10 sequence. Vernier allows continuous adjustment between calibrated ranges and extends minimum sensitivity to at least 50 v/cm.

ATTENUATOR ACCURACY:

$\pm 3\%$.

BANDWIDTH:

UPPER LIMIT: Switch selected at front panel; 400, 40, or 4 kc.

LOWER LIMIT: Input and amplifier coupling set to DC: dc. Input set to DC and amplifier set to AC: dc from 20 v/cm to 50 mv/cm; approximately 0.1 cps on 20 mv/cm, increasing with sensitivity to approximately 20 cps at 0.1 mv/cm. Input set to AC and Amplifier set to DC: 2 cps.

DIFFERENTIAL INPUT:

Differential input may be used on all attenuator ranges. Common mode rejection is at least 40 db on 0.1 mv/cm to 0.2 v/cm ranges (signal not to exceed 4 volts peak-to-peak), at least 30 db on 0.5 v/cm to 20 v/cm ranges (signal not to exceed 40 volts peak-to-peak on 0.5, 1, and 2 v/cm ranges and 400 volts peak-to-peak on 5, 10, and 20 v/cm ranges). Measured at 1 kc.

INPUTS:

Two BNC signal jacks. AC or dc coupling of either or both inputs. Isolation between inputs at least 80 db.

INPUT IMPEDANCE:

1 megohm shunted by 45 pf, constant on all attenuator ranges.

MAXIMUM INPUT:

600 volts (dc + peak ac).

PRICE:

\$210.00

TENTATIVE SPECIFICATIONS

-hp-

MODEL 1401A

DUAL TRACE AMPLIFIER

MODE OF OPERATION:

1. Channel A alone.
2. Channel B alone.
3. Channel A and Channel B displayed on alternate sweeps.
4. Channel A and Channel B switched alternately at approximately 100 kc.

with trace blanking during switching.

5. Channel A minus Channel B.

SENSITIVITY:

Each channel has sensitivities from 1 mv/cm to 10 v/cm in 1, 2, 5, 10 sequence. Vernier allows continuous adjustment between calibrated ranges and extends minimum sensitivity to at least 25 v/cm.

ATTENUATOR ACCURACY:

$\pm 3\%$.

BANDWIDTH:

Input and Amplifier coupling set to DC: dc to 450 kc. Input set to DC and Amplifier set to AC: dc to 450 kc for sensitivity from 50 mv/cm to 10 v/cm; from 1 mv/cm to 20 mv/cm, lower cutoff depends on sensitivity: approximately 0.5 cps (to 450 kc) at 20 mv/cm and 10 cps (to 450 kc) at 1 mv/cm. Input set to AC and Amplifier set to DC: 2 cps to 450 kc.

DIFFERENTIAL INPUT:

Both channels, with associated attenuators, may be switched to one channel to give differential input.

COMMON MODE REJECTION:

At least 40 db on 1 mv/cm to 0.1 v/cm ranges (signal not to exceed 4 v peak-to-peak), at least 30 db on 0.2 v/cm to 10 v/cm ranges (signal not to exceed 40 v peak-to-peak on 0.2, 0.5, and 1 v/cm ranges and 400 v peak-to-peak on 2, 5, and 10 v/cm ranges). Measured at 1 kc.

INPUT IMPEDANCE:

1 megohm shunted by 45 pf.

MAXIMUM INPUT VOLTAGE:

600 volts (dc + peak ac).

POLARITY OF PRESENTATION:

+ up or - up selectable for Channel A.

PRICE:

\$325.00.

TENTATIVE SPECIFICATIONS

-hp-

MODEL 1402A

DUAL TRACE AMPLIFIER

MODE OF OPERATION:

1. Channel A alone.
2. Channel B alone.
3. Channel A and Channel B displayed on alternate sweeps.
4. Channel A and Channel B switched alternately at approximately 100 kc, with trace blanking during switching.
5. Channel A plus Channel B; differential operation obtained by inverting polarity of Channel A.

SENSITIVITY:

Each channel has sensitivities from 5 mv/cm to 10 v/cm in 11 calibrated

ranges in 1, 2, 5, 10 sequence. Vernier allows continuous adjustment between calibrated ranges and extends minimum sensitivity to at least 25 v/cm.

ATTENUATOR ACCURACY:

$\pm 3\%$.

BANDWIDTH (6 cm reference signal):

DC COUPLED: dc to 20 Mc.

AC COUPLED: 2 cps to 20 Mc.

SIGNAL DELAY:

Signal is delayed so that leading edge of fast rise signal which triggers sweep is visible at start of sweep.

INPUT IMPEDANCE:

1 megohm shunted by 35 pf.

MAXIMUM INPUT:

600 volts (dc + peak ac).

PRICE:

\$550.00.

TENTATIVE SPECIFICATIONS

-hp-

MODEL 1403A

AC DIFFERENTIAL AMPLIFIER

SENSITIVITY:

10 μ v/cm to 100 mv/cm in 13 calibrated ranges in 1, 2, 5, 10 sequence. Vernier allows continuous adjustment between calibrated ranges and extends minimum sensitivity to at least 250 mv/cm.

ATTENUATOR ACCURACY:

$\pm 3\%$.

BANDWIDTH:

0.1 cps to 400 kc maximum; upper and lower limits selected independently with front panel controls.

DIFFERENTIAL INPUT:

Differential input available on all attenuator ranges. Common mode rejection may be adjusted to at least 94 db on all ranges for input signals from 10 cps to 10 kc and up to 10 volts peak-to-peak.

INPUT IMPEDANCE:

10 megohms shunted by approximately 50 pf.

INPUTS:

Two BNC signal jacks. AC coupling of either or both inputs. Isolation between inputs at least 80 db.

MAXIMUM INPUT:

600 volts (dc + peak ac).

NOISE:

Less than 20 μ v peak-to-peak at 100 kc bandwidth.

PRICE:

\$350.00.

Prices f.o.b. factory
Data subject to change without notice.

graphing single transients.

The Model 1420A includes a dc-coupled horizontal amplifier input so that external signals may be used to drive the CRT trace. Sensitivity of this input is either 1 v/cm or 100 mv/cm, depending on whether the sweep magnifier is in the $\times 1$ or $\times 10$ position.

**MODEL 1421A
DELAYING SWEEP PLUG-IN**

The Model 1421A incorporates two sweep generators into one plug-in which, along with simplified operation, includes tunnel-diode triggering and pick-off circuits for minimum jitter. A maximum sweep speed of 20 ns/cm, automatic triggering, and the *Mixed Sweep* mode of operation make this plug-in the most versatile of its type.

The 1421A Time Base has six modes of operation. In the *Normal* mode the sweep operates in conventional fashion. In the two *Intensified* modes, a brightened portion of the trace shows the start and duration of the faster delayed sweep (upper trace in Fig. 4). With the mode switch turned to one of the two delayed sweep positions, the delayed sweep then drives the CRT beam so that the portion of the waveform previously delineated by the brightened segment is expanded to fill the screen (middle trace in Fig. 4). In the delayed sweep *Trigger* mode, the delayed sweep starts at the end of the

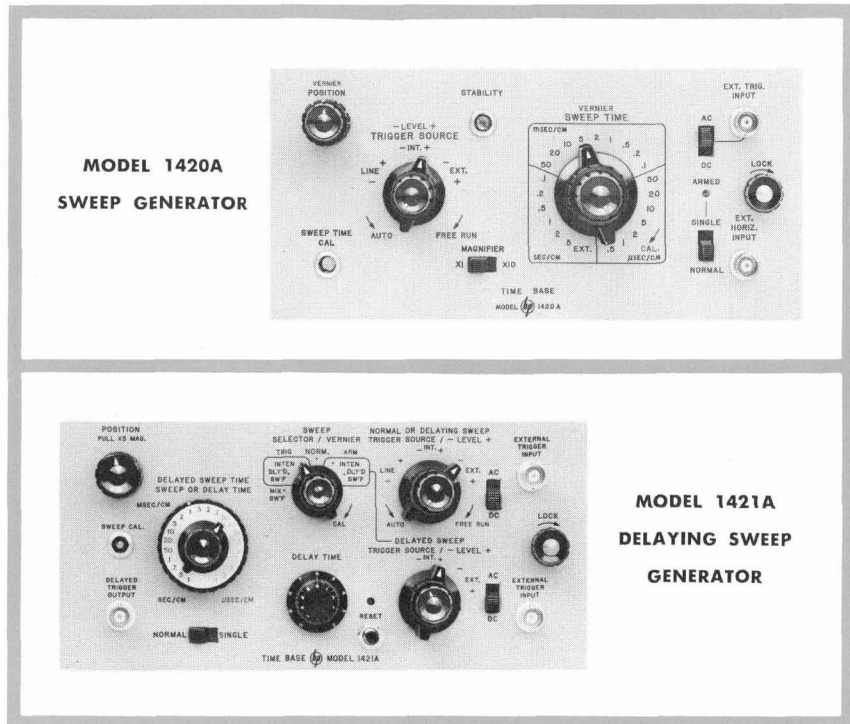

delay interval selected by front panel controls. In the delayed sweep *Arm* mode, the delayed sweep is started by the first trigger following the delay interval. Either *Trigger* or *Arm* modes likewise may be selected for the *Intensified* opera-

tion described earlier.

The *Mixed* sweep mode of operation generates a time base that changes speed during the trace (lower trace in Fig. 4). For the initial portion of the trace, a relatively slow sweep is generated. At

**SWEEP GENERATOR
PLUG-INS**

SPECIFICATIONS

-hp-

**MODEL 1420A
SWEEP GENERATOR**

INTERNAL SWEEP:

22 ranges, 0.5 μ sec/cm to 5 sec/cm in 1, 2, 5, 10 sequence. Vernier provides continuous adjustment between ranges and extends slowest sweep to at least 12.5 sec/cm.

MAGNIFICATION:

X10; expands fastest sweep to 50 nsec/cm.

SWEEP ACCURACY:

$\pm 3\%$, typically within $\pm 1\%$; $\pm 5\%$ when magnified, typically within $\pm 3\%$.

TRIGGERING:

AUTOMATIC: Base line displayed in absence of triggering signal.

INTERNAL: 40 cps to 500 kc from signals causing 0.5 cm or more deflection; also from line voltage.

EXTERNAL: 40 cps to 500 kc from signals 0.5 v peak-to-peak or more.

TRIGGER SLOPE: Positive or negative slope of external or internal signals.

AMPLITUDE SELECTION:

INTERNAL: 10 cps to 20 Mc; 0.5 cm vertical deflection required to 10 Mc, slightly decreasing sensitivity to 20 Mc.

EXTERNAL: DC coupled: dc to 20 Mc; 0.5 v p-p required to 10 Mc, slightly decreasing sensitivity to 20 Mc. AC coupled: 10 cps to 20 Mc; 0.5 v p-p required to 10 Mc, slightly decreasing sensitivity to 20 Mc.

TRIGGER POINT AND SLOPE: Inter-

nally from any point on displayed waveform or line voltage, externally from any point between -10 and $+10$ volts; positive or negative slope.

SINGLE SWEEP:

Front panel switch selects single sweep operation.

HORIZONTAL INPUT:

Approximately 1 v/cm or 0.1 v/cm sensitivity, depending on magnifier setting; dc coupled; input impedance: 1 megohm shunted by less than 50 pf.

PRICE:

\$250.00.

TENTATIVE SPECIFICATIONS

-hp-

**MODEL 1421A
TIME BASE AND DELAY GENERATOR
NORMAL SWEEP**

INTERNAL SWEEP:

22 ranges, 0.1 μ sec/cm to 1 sec/cm in 1, 2, 5, 10 sequence. Accuracy is typically within 1%, always within 3%. Vernier provides continuous adjustment between ranges and extends slowest sweep to at least 2.5 sec/cm.

MAGNIFICATION:

X5, expands fastest sweep to 20 nsec/cm. Accuracy is typically within 3%, always within 5%.

TRIGGERING:

AUTOMATIC: Base line displayed in absence of input signal.

INTERNAL: 40 cps to greater than 20 Mc from signals causing 0.5 cm or more vertical deflection; also from line voltage.

EXTERNAL: 40 cps to greater than 20 Mc from signals 0.5 volt peak-to-peak or more.

TRIGGER SLOPE: Positive or negative.

AMPLITUDE SELECTION:

INTERNAL: 10 cps to greater than 20

Mc from signals causing 0.5 cm or more deflection; also from line voltage.

EXTERNAL: DC to greater than 20 Mc from signals 0.5 v p-p or more.

TRIGGER POINT AND SLOPE: Internally from any point on displayed waveform, externally from any point between -10 and $+10$ volts; positive or negative slope.

SINGLE SWEEP: Front panel switch selects single sweep operation.

DELAY FUNCTION

DELAYED SWEEP:

22 ranges, 0.1 μ sec/cm to 1 sec/cm in 1, 2, 5, 10 sequence. Accuracy is typically within 1%, always within 3%.

DELAY TIME:

Continuously variable from 0.1 μ sec to 10 sec.

ACCURACY:

$\pm 1\%$. Incremental delay accuracy is within 0.2%. Time jitter is always less than 1 part in 50,000.

DELAY FUNCTION:

Mixed sweep. Intensified sweep, triggered or armed. Delayed sweep, triggered or armed.

TRIGGERING (of armed Delayed Sweep): INTERNAL: 10 cps to greater than 20 Mc from signals causing 0.5 cm or more deflection.

EXTERNAL: DC to greater than 20 Mc from signals 0.5 v p-p or more.

TRIGGER POINT AND SLOPE: Internally from any point of waveform, externally from any point from -10 to $+10$ volts, positive or negative slope.

DELAYED TRIGGER OUTPUT: Approximately $+10$ volts.

PRICE:

\$625.00.

Prices f.o.b. factory
Data subject to change without notice.

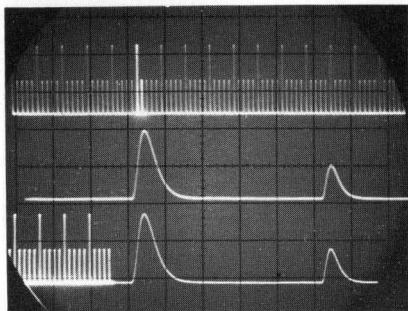

Fig. 4. Triple-exposure oscillogram shows Intensified mode of Model 1421A Delaying Sweep Generator in upper trace. Normal sweep drives CRT while Delayed sweep merely brightens trace. In middle trace, Delayed sweep drives CRT so that brightened segment of top trace expands to fill screen. Bottom trace shows Mixed sweep operation, with Normal sweep driving CRT until faster, later-starting Delayed sweep catches up and drives CRT for remainder of trace.

some point selected by the delay time control, sweep speed increases (Fig. 5). This permits detailed examination of an expanded part of a pulse train while the previous unexpanded portion is retained on the display for reference.

The delay from the start of the normal sweep to the start of the delayed sweep is continuously variable from 0.1 μ second to 10 seconds with 1% accuracy. Time jitter is less than 1 part in 50,000. A delay trigger, occurring at the end of the delay interval, is available at a front panel jack for use with related equipment.

The two sweep time controls are concentric but can be moved independently. The calibrated sweep speeds, from 1 sec/cm to 0.1 μ sec/cm, are accurate typically within 1%. The vernier sweep speed control extends the slowest sweep to 2.5 sec/cm, and the $\times 5$ magnifier expands the fastest sweep to 20 nsec/cm for both time bases. A capacitance driver is in-

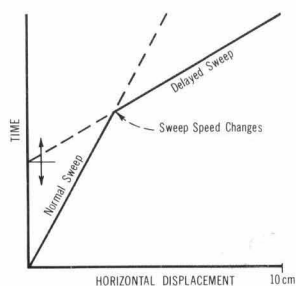
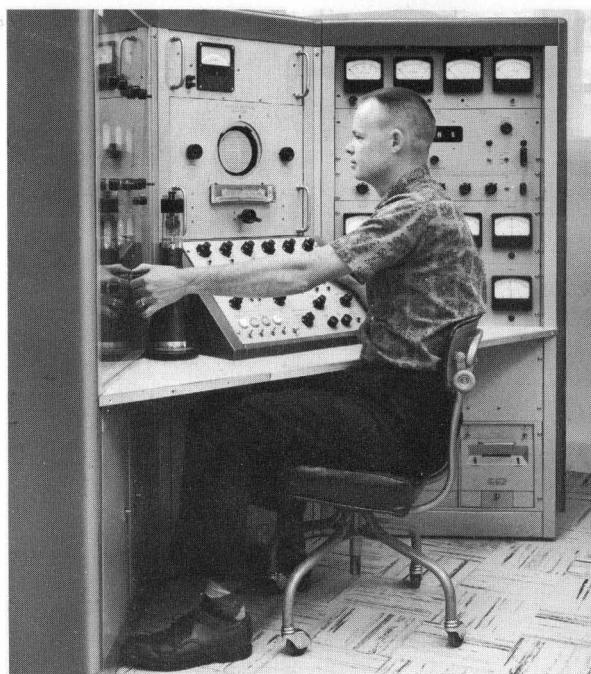

Fig. 5. Graph of time vs displacement shows mixed sweep operation of Model 1421A Sweep Generator. Trace is driven initially by Normal sweep until overtaken by later-starting Delayed sweep. Trace then is driven by faster Delayed sweep for remainder of sweep.



Cathode-ray tube in new oscilloscope is produced in -hp- CRT facility. Tube designer David Chaffee checks tube performance at test console.

cluded in the horizontal amplifier to maintain sweep linearity even on the fastest expanded sweep speeds.

Automatic triggering also is provided on the Normal sweep in this plug-in so that a baseline is displayed in the absence of an input signal. When triggering from

a selected amplitude, the sweep can be started at any point on a waveform supplied externally or internally. The tunnel diode trigger circuit achieves stable triggering well beyond 20 Mc without counting down. A separate front panel switch permits single sweep operation.

SPECIFICATIONS -hp- MODEL 140A OSCILLOSCOPE

PLUG-INS:

Accepts 1400 series plug-ins; upper compartment for horizontal axis and lower compartment for vertical axis. Center shield may be removed to provide double-sized compartment for dual-axis 1400 series unit.

CALIBRATOR:

1 v and 10 v peak-to-peak line frequency square waves. Accuracy: $\pm 1\%$ within $+15$ to $+35^\circ\text{C}$, $\pm 3\%$ within 0 to $+55^\circ\text{C}$. Risettime: 0.5 μ sec or less.

BEAM FINDER:

Brings trace on screen regardless of setting of plug-ins' position controls.

INTENSITY MODULATION:

Approximately ± 20 v blanks trace of normal intensity. AC coupled input on rear panel.

CATHODE RAY TUBE:

7.5 kv post accelerator tube with aluminumized P31 phosphor (P2, P7, and P11 available at no extra charge). Non-glare safety glass faceplate. Internal graticule 10 x 10 cm in cm squares; major horizontal and vertical axes have 0.2 cm subdivisions.

POWER:

115 or 230 v $\pm 10\%$, 50 to 60 cps, normally less than 285 watts (depends on plug-ins).

DIMENSIONS:

16 $\frac{3}{4}$ in. wide, 9 in. high, 18 $\frac{3}{4}$ in. deep overall. Hardware furnished for quick conversion to 8 $\frac{3}{4}$ in. x 19 in. rack mount, 16 $\frac{3}{4}$ in. deep behind panel.

WEIGHT:

Net, 37 lbs. (without plug-ins).

PRICE:

\$575.00

TENTATIVE SPECIFICATIONS -hp- MODEL 1415A TIME DOMAIN REFLECTOMETER

SYSTEM (in reflectometer configuration):

RISE TIME: Less than 150 ps.
OVERSHOOT: 5% or less (down to $\frac{1}{2}$ in 1 ns).

INTERNAL REFLECTIONS: Less than 8% (does not limit resolution).

REFLECTOMETER SENSITIVITY: Reflection coefficients as small as 0.001 can be observed.

REP RATE: 200 kc.

SIGNAL CHANNEL:

RISE TIME: Approximately 90 ps.
SENSITIVITY: 1 mv/cm to 0.1 v/cm in 1, 2, 5, 10 sequence.

INPUT: 50 ohms, feed-through type.

NOISE: Less than 0.2 mv peak-to-peak.

INTERNAL PICKUP: Less than 0.2 mv peak.

DYNAMIC RANGE: ± 1.0 v.

ATTENUATOR ACCURACY: $\pm 3\%$.

PULSE GENERATOR:

AMPLITUDE: Approximately 0.25 v into 50 ohms (0.5 v into open circuit).

RISE TIME: Approximately 50 ps.

OUTPUT IMPEDANCE: 50 ohms ± 1 ohm.

DROOP: Less than 1%.

TIME SCALE:

SWEEP SPEEDS: 20 ns/cm to 200 ns/cm in 1, 2, 5, 10 sequence; accuracy: $\pm 5\%$.

MAGNIFICATION: X1 to X200 in 1, 2, 5, 10 sequence.

DELAY CONTROL: 0 to 2000 ns, calibrated.

JITTER: Less than 10 ps.

PRICE:

\$950.00.

Prices f.o.b. factory
Data subject to change without notice.